

PLACED IN THE
CONCRETE BLOCK

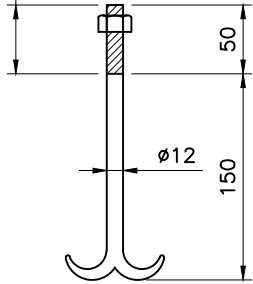

ROUTE MARKER (HT)

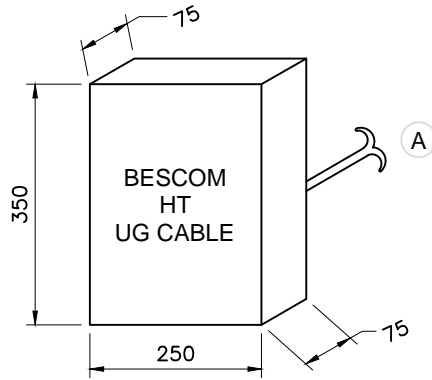

JOINT MARKER (HT)

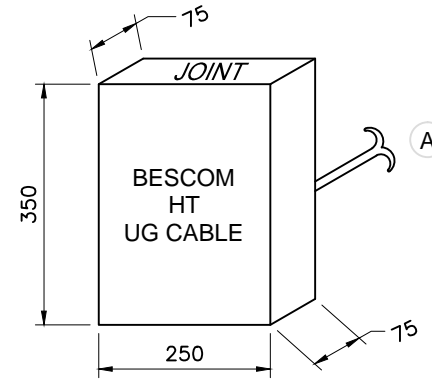

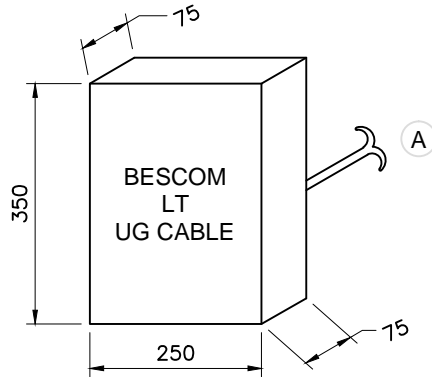

ROUTE MARKER (LT)

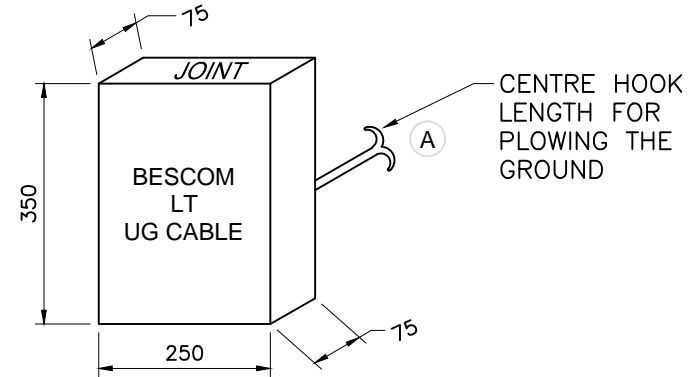

JOINT MARKER (LT)

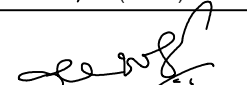
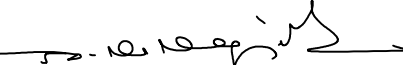

	Signatures	All dimensions are in mm unless otherwise stated.	<p>ಬೆಸಕಂ</p>  <p>BESCOM</p>
Chd	 AGM (QS&S)	ROUTE MARKER (HT & LT) JOINT MARKER (HT & LT)	Approved:
Sub	 DGM (QS&S)		 General Manager, (Elec.) QS&S
SCALE: N.T.S			DRG.NO.BESCOM/GM/QS&S/79 REV-002 DATED:24-11-2018